

Do not scale

Third angle projection 

All dimensions in millimetres

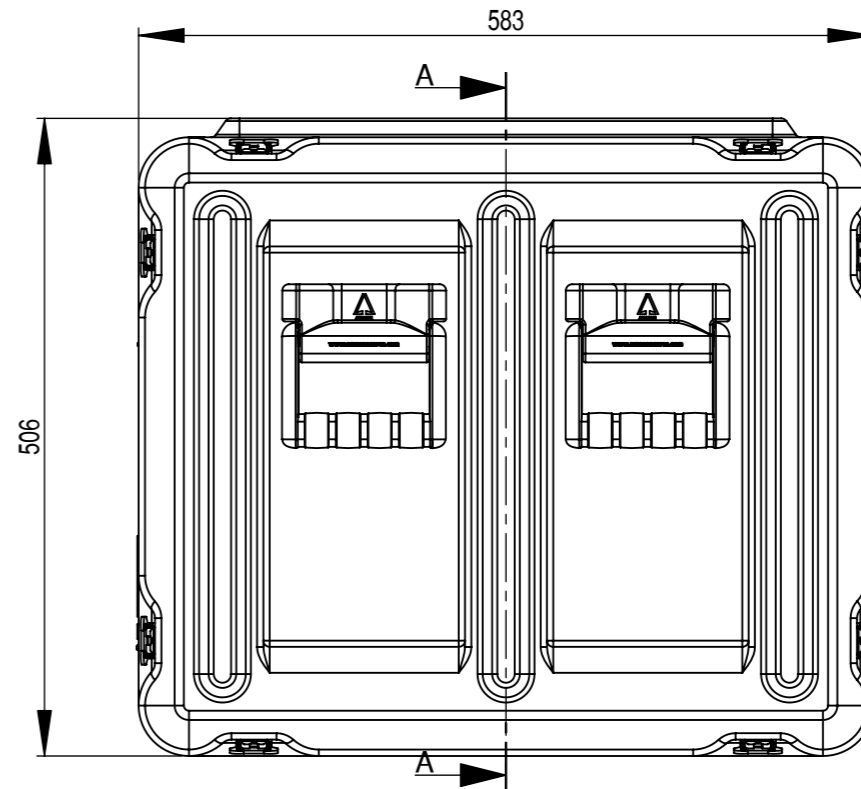
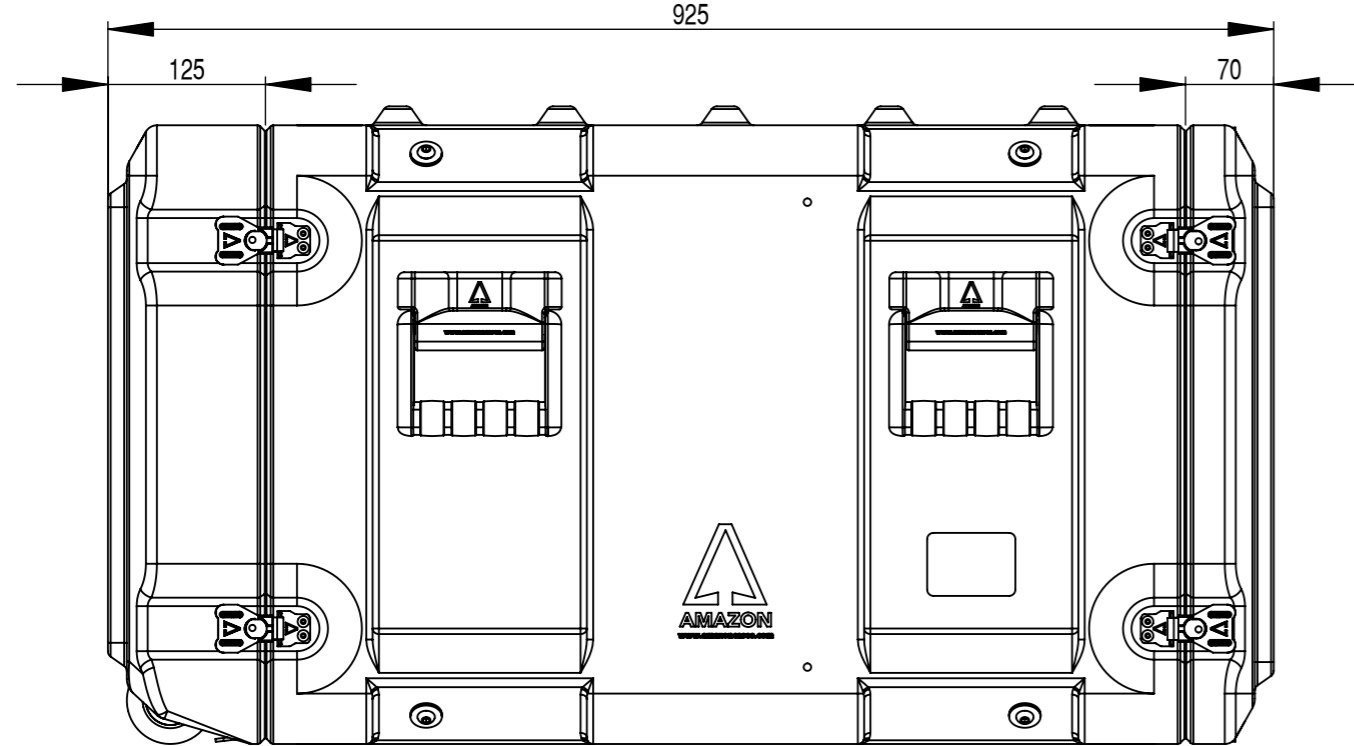
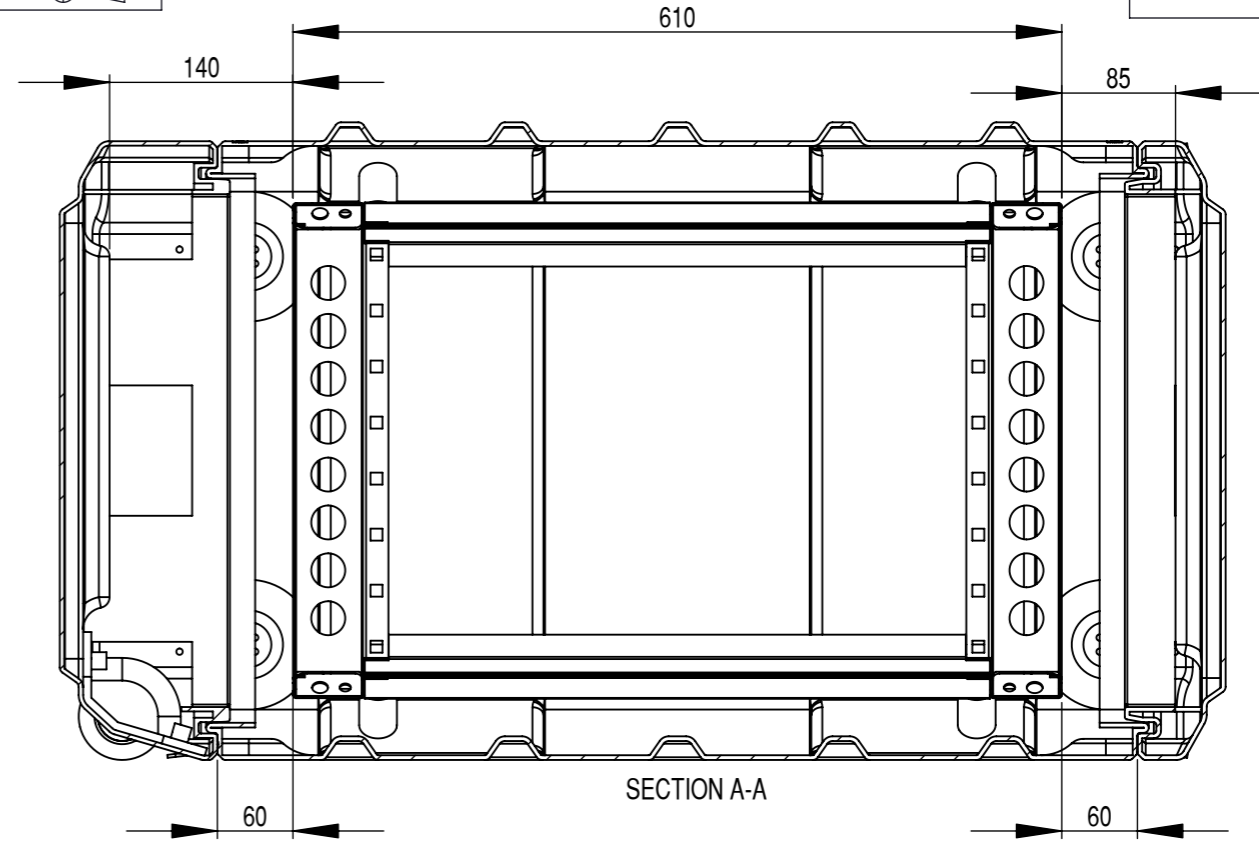
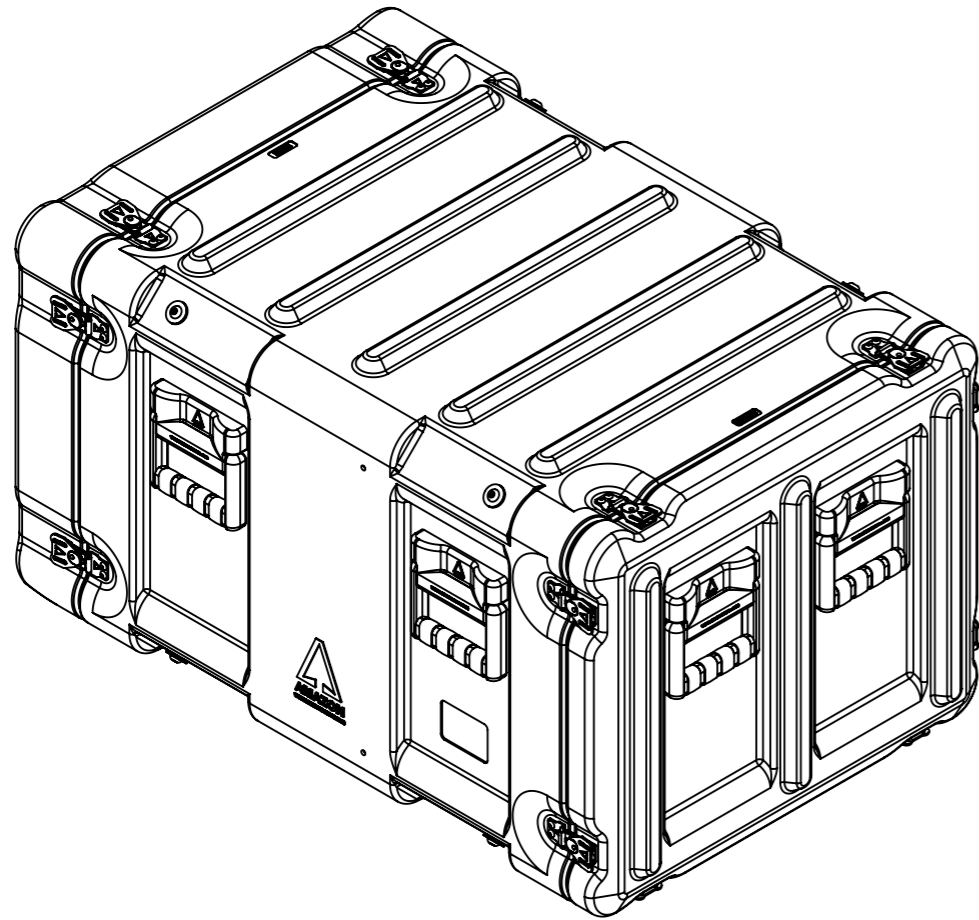

Rack options include:
 Removable inner frame
 Pressure relief valves
 Humidity indicators
 Equipment support shelves
 19" accessories
 Wheels
 Various colours

Please phone for more options

Physical Specifications			
Rack Size	8U	Weight (Kg)	24.1
External Dimensions (mm)	Hardware		
Height	506	No of Handles	6
Width	583	No of Catches	16
Depth	925		

Copyright © 2007 Amazon Cases
 This drawing is the property of Amazon Cases & the information on it is confidential & it is not to be used for any other purpose without the prior written consent of Amazon Cases

Material
 Polyethylene

Colour
 Various Colours Available



Amazon Cases
 Worton Hall Industrial Estate
 Worton Road
 Isleworth
 Middlesex
 TW7 6ER
 UK

Title		Amazon Rack - 8U 610 Frame with wheels		
Drawn By	Date	Drg. No.	Sheet No.	Issue No.
GS	11/07/06	AR08610712	1 Of 1	1