

Do not scale

Third angle projection 

All dimensions in millimetres

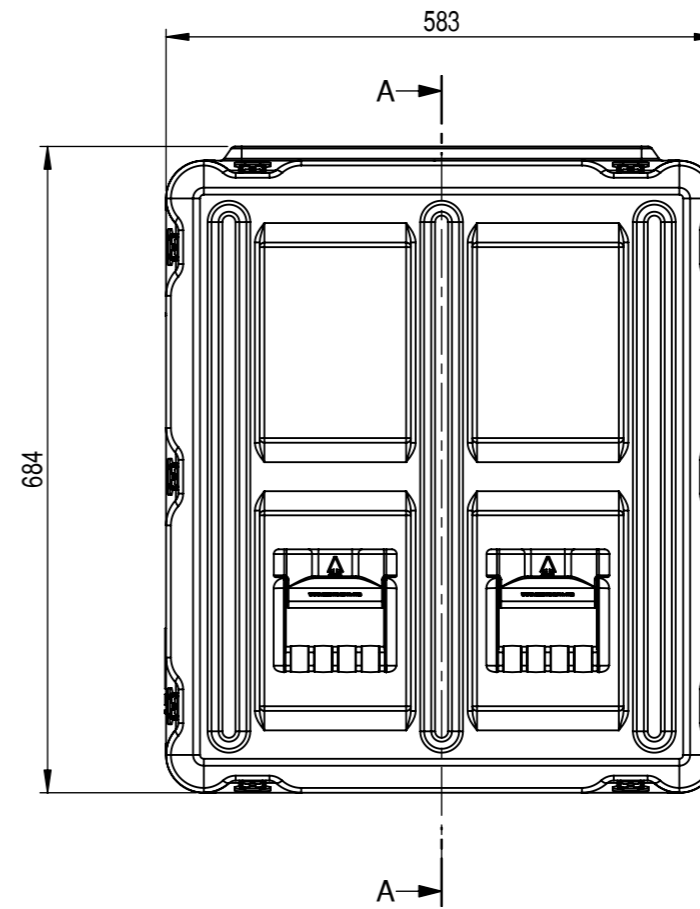
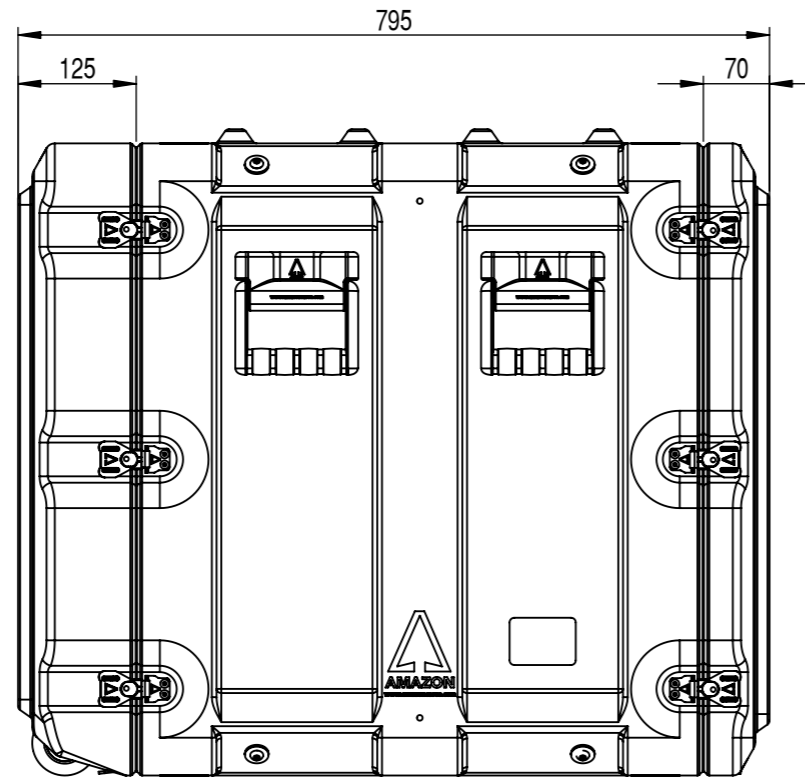
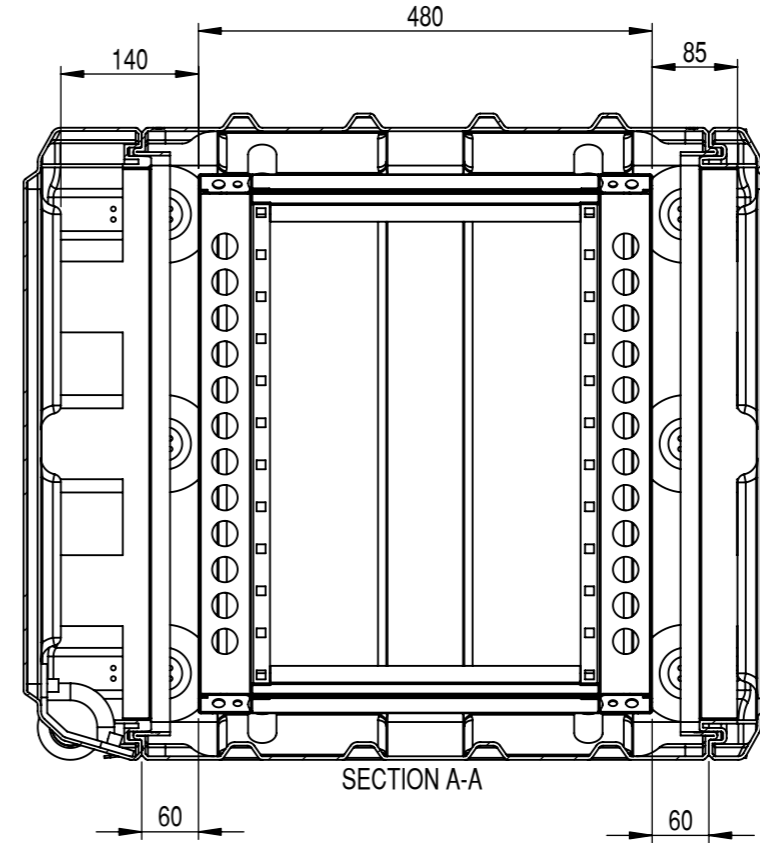
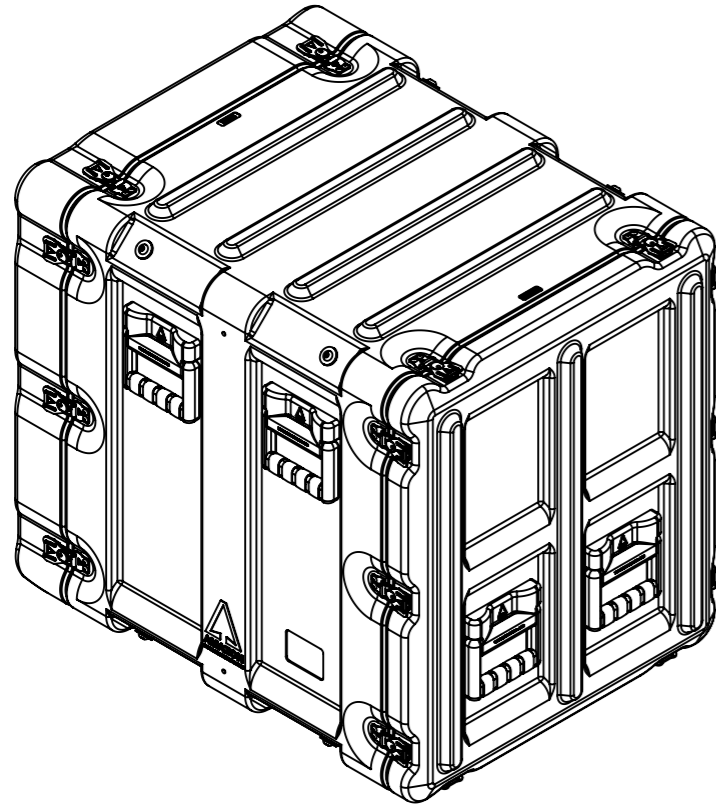

Rack options include:  
 Removable inner frame  
 Pressure relief valves  
 Humidity indicators  
 Equipment support shelves  
 19" accessories  
 Wheels  
 Various colours

Please phone for more options

Physical Specifications			
Rack Size	12U	Weight (Kg)	25.1
External Dimensions (mm)		Hardware	
Height	684	No of Handles	6
Width	583	No of Catches	20
Depth	795		

Copyright © 2007 Amazon Cases  
 This drawing is the property of Amazon Cases & the information on it is confidential & it is not to be used for any other purpose without the prior written consent of Amazon Cases

Material  
 Polyethylene  
 Colour  
 Various Colours Available



Amazon Cases  
 Worton Hall Industrial Estate  
 Worton Road  
 Isleworth  
 Middlesex  
 TW7 6ER  
 UK

Title				
Amazon Rack - 12U 480 Frame with wheels				
Drawn By	Date	Drg. No.	Sheet No.	Issue No.
GS	11/07/06	AR12480712	1 Of 1	1